

 **breviglieri**

POWER HARROWS

ERPICI ROTANTI

HERSES ROTATIVES

KREISELEGGEN

GRADAS ROTATIVAS



 **breviglieri**

Uomini, idee, macchine.



The range

Available for tractors from 30 up to 260 HP

- I Disponibili per trattori da 30 a 260 cv
- F Disponibles pour tracteurs de 30 à 260 cv
- D Verfügbar für Traktoren von 30 bis 260 PS
- E Disponibles para tractores de 30 a 260 cv

I La gamma F La gamme D Die Auswahl E La gama

Mekfarmer 80



30 - 80 HP

cm. 110 - 130 - 150 - 170 - 190

Mekfarmer 100



60 - 100 HP

cm. 200 - 230 - 250 - 300

Mekfarmer 120



90 - 120 HP
cm. 250 - 300 - 350

Mekfarmer 150



90 - 150 HP
cm. 250 - 300 - 350

Mekfarmer 170



100 - 170 HP
cm. 300 - 350 - 400

Mekfarmer 220



140 - 220 HP
cm. 300 - 350 - 400 - 450

Mekfarmer K180



100 - 180 HP
cm. 300 - 350 - 400

Mekfarmer K230



140 - 230 HP
cm. 300 - 350 - 400 - 450

Mekfarmer K270



150 - 270 HP
cm. 300 - 350 - 400 - 450



BALL BEARINGS

- 1 Cuscinetti a sfera F Roulements à billes
- 2 Kugellager E Cojinetes a esferas

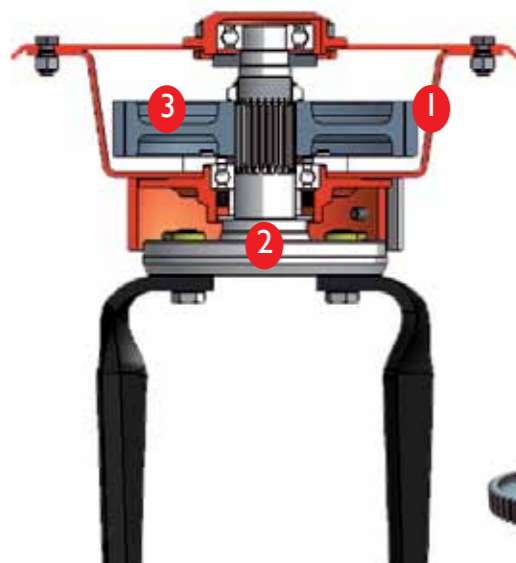

TAPERED ROLLER BEARINGS

- 1 Cuscinetti conici F Roulements coniques
- 2 Konische Lagerungen E Cojinetes cónicos

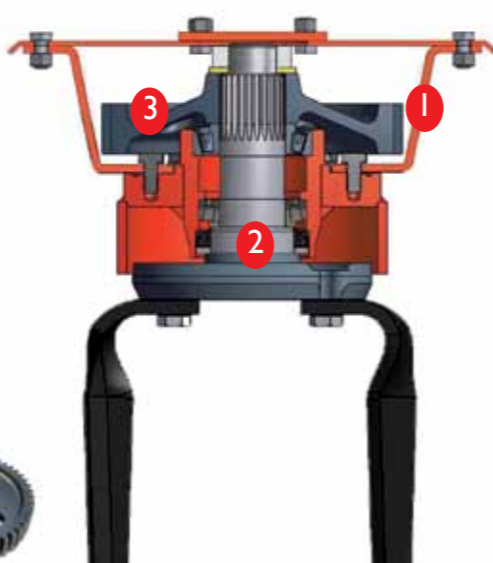

SPECIAL MOUNTING OF BLADES

- 1 Fasatura coltelli F Décalage des couteaux D Zinken E Montaje special cuchillas

This system to assembly the blades allows:

- 1 Questo particolare sistema di montaggio dei coltelli consente:
- 2 Ce système spécial de montage des lames permet de:
- 3 Dieses spezielle Zinkenmontagesystem erlaubt:
- 4 Este sistema de montaje de las cuchillas permite de:

2 To reduce the absorption of power and a saving fuel consumption

- 1 Ridurre l'assorbimento di potenza e consumi di carburante
- 2 Réduire l'absorption de puissance et consommations de carburant
- 3 Die Absorption der Kraft und des Treibstoffverbrauchs zu verringern
- 4 Reducir la absorción de potencia y consumos de carburante

1 To eliminate the vibrations

- 1 Eliminare le vibrazioni
- 2 Éliminer les vibrations
- 3 Die Vibrationen zu entfernen
- 4 Eliminar las vibraciones

3 Fine clods for a perfect seeded

- 1 Zolle fini per una perfetta semina
- 2 Des mottes fines pour une parfaite semée
- 3 Dünne Scholle für eine perfekte Aussaat
- 4 Terrones finos para una perfecta siembra

MOD.	1	2	3	MOD.	1	2	3	MOD.	1	2	3
Mekfarmer 80	mm 3	mm 45	40	Mekfarmer 150	mm 5	mm 50	48	Mekfarmer K180	mm 7+7	mm 55	40
Mekfarmer 100	mm 5	mm 45	40	Mekfarmer 170	mm 7	mm 50	48	Mekfarmer K230	mm 7+7	mm 55	40
Mekfarmer 120	mm 5	mm 50	48	Mekfarmer 220	mm 7	mm 50	48	Mekfarmer K270	mm 7+7	mm 55	40

- 1 Flat-pan thickness steel F Spessore lamiera vasca E Epaisseur tôle D Dick des Bleches der Wanne E Espesor plancha
- 2 Side blade holder shaft diam. F Diametro albero portadente laterale E Diamètre arbre porte dent latéral D Seitliche Zinkenträger durchmesser E Diametro eje porta-diente central
- 3 Nr. tines gear transmission F N° denti ingranaggio di trasmissione E Nombre dents engrange D Nr. der Zahnen der Antriebszahnäder E Nr. dientes engranje de transmisión

SUPERFAST

Without tools! Without effort!

- 1 Senza attrezzi! Senza fatica!
- 2 Sans outils! Sans fatigue!
- 3 Ohne Werkzeug! Ohne Mühe!
- 4 Sin las herramientas! Sin esfuerzo!

The BREVIGLIERI system in order to replace blades in a moment

- 1 Il sistema Breviglieri per sostituire gli utensili in un attimo
- 2 Le système BREVIGLIERI pour changer les outils dans un seul instant
- 3 Das BREVIGLIERI System für di Werkzeuge sofort zu ersetzen
- 4 El sistema BREVIGLIERI para substituir las cuchillas en un momento

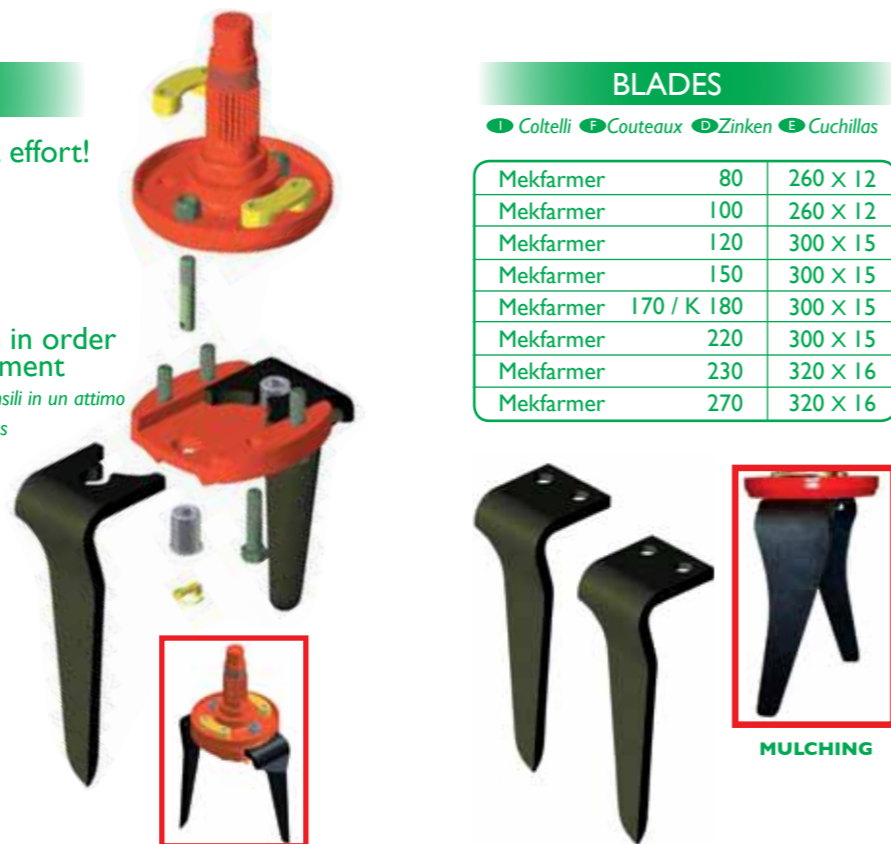

BLADES

- 1 Coltelli F Couteaux D Zinken E Cuchillas

Mekfarmer 80	260 X 12
Mekfarmer 100	260 X 12
Mekfarmer 120	300 X 15
Mekfarmer 150	300 X 15
Mekfarmer 170 / K 180	300 X 15
Mekfarmer 220	300 X 15
Mekfarmer 230	320 X 16
Mekfarmer 270	320 X 16

MULCHING

AVAILABLE ON

- 1 Disponibile F Disponible D Verfügbar E Disponible
- Mekfarmer 150 - 170 - 220 - K180 - K230 - K270

SIDE SHIELDS

- 1 Deflettori laterali F Déflécteurs latéraux D Seitenschilde E Deflectores laterales

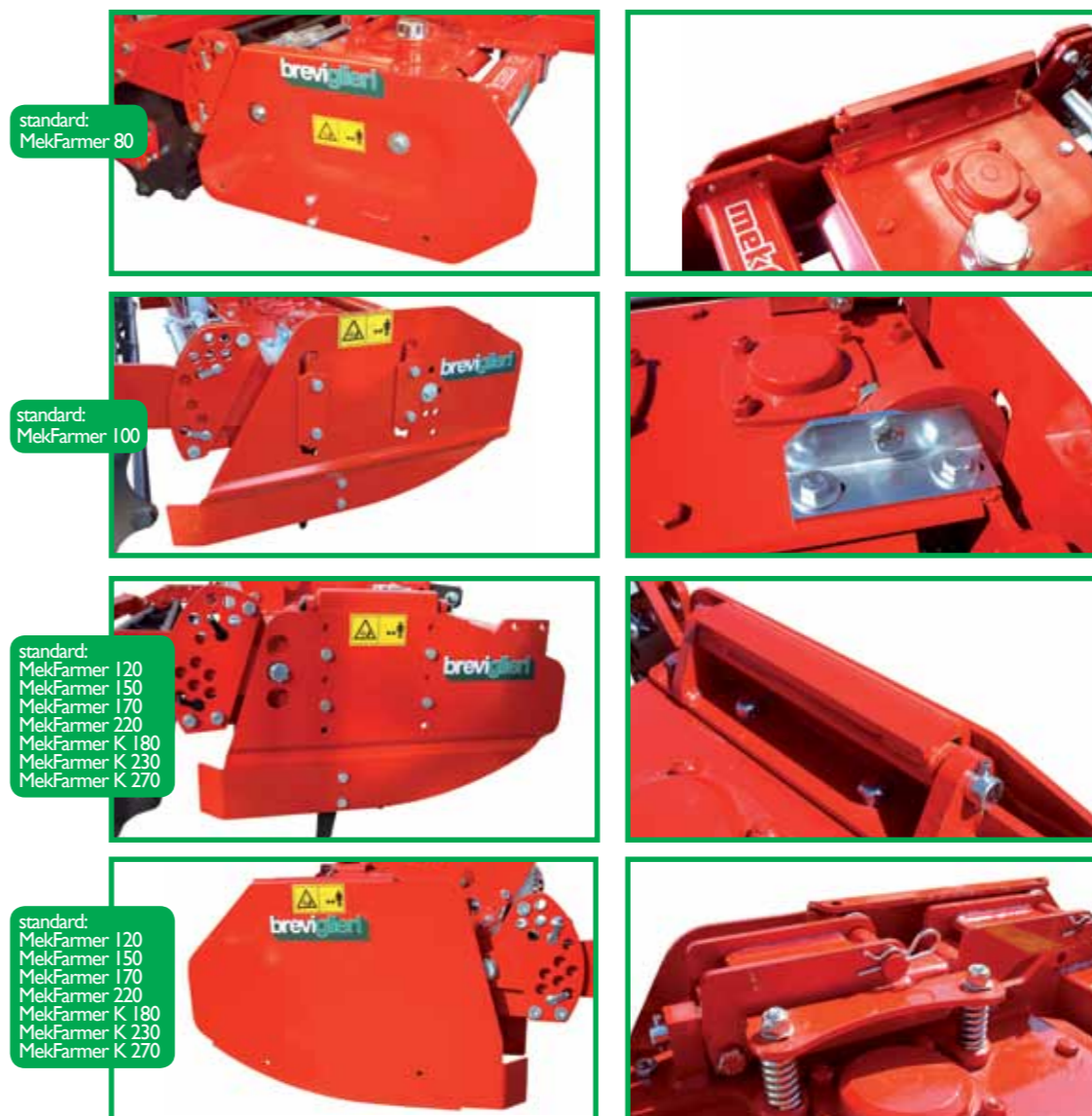

REAR ROLLERS

1 Rulli posteriori 2 Rouleaux arrière 3 Hintere Walzen 4 Rodillos posteriores



Spiked roller (Ø 477-525) (Ø 102-164)
 1 Rullo dentato
 2 Rouleau à dents
 3 Zinkenwalze
 4 Rodillo a dientes



Cage roller (Ø 370-405-450-500)
 1 Rullo gabbia
 2 Rouleau cage
 3 Stabwalze
 4 Rodillo jola



Packer roller (Ø 406-464-500-550)
 1 Rullo packer
 2 Rouleau packer
 3 Zahnpackerwalze
 4 Rodillo packer



Spiked roller maxi (Ø 525) (Ø 273)
 1 Rullo dentato maxi
 2 Rouleau à dents maxi
 3 Zinkenwalze maxi
 4 Rodillo dentado maxi



Crumbling roller (Ø 412-500)
 1 Rullo sminuzzatore
 2 Rouleau emoteur
 3 Krumpenpackerwalze
 4 Rodillo desmenuzador



Spiral roller (Ø 460)
 1 Rullo spirale
 2 Rouleau spire
 3 Krummenpackerwalze
 4 Rodillo espiral

ROLLERS ADJUSTEMENT

1 Regolazione rulli 2 Réglage rouleaux 3 Walzenverstellung 4 Ajuste rodillos



STANDARD
 With pins
 1 A perni
 2 Par tourillons
 3 Mit Spindel
 4 A pernos



OPTION
 Mechanical jacks (2)
 1 Martinetti meccanici (2)
 2 Vérins mécaniques (2)
 3 Mit Bolzen (2)
 4 Con tornillos (2)



OPTION
 Hydraulic jacks (2)
 1 Martinetti idraulico (2)
 2 Vérins hydraulique (2)
 3 Hydraulische Zylinder (2)
 4 Cilindro hidráulico (2)

PTO SHAFT

1 Cardano 2 Cardan 3 Gelenkwille 4 Cardan



With shear bolt
 1 Con limitatore a bulloni
 2 Avec limiteurs à boulons
 3 Mit Scherstift
 4 Con limitador a bulón

STANDARD
 Mekfarmer 80-100



With slip clutch
 1 Con frizione a dischi
 2 Avec sécurité à disques
 3 Rutsckupplung
 4 Con embragues de discos

STANDARD
 Mekfarmer 120-150-170-220
 Mekfarmer K180-K230-K270

OPTION
 Mekfarmer 80-100



With cam clutch
 1 Con sicurezza automatica
 2 Avec sécurité à came
 3 Mit Nockenschaltkupplung
 4 Con embrague de seguridad

OPTION
 Mekfarmer 120-150-170-220
 Mekfarmer K180-K230-K270

HYDRAULIC SEEDER LINKAGE

1 Attacco idraulico seminatrici
 2 Attelage hydraulique semair
 3 Hydraulische Drillmaschinenanbauteile
 4 Enganche hidráulico sembradora



MAX LOAD KG 2000

BACK REFLEX PANELS



1 Pannelli retroriflettenti
 2 Panneaux de signalisation
 3 Erkennungstafel
 4 Paneles retroreflejantes

OPTION
 Mekfarmer 120-150
 170-220
 Mekfarmer K180
 K230-K270

STONE PROTECTION

1 Protezione sassi
 2 Protéctions cailloux
 3 Wickel Steinschutz
 4 Protección piedras



STANDARD
 Mekfarmer 150-170-220
 Mekfarmer K180-K230-K270

OPTION
 Mekfarmer 80-100-120

REAR PTO

1 PDF Posteriore
 2 PDF arrière
 3 Hinter Durchtrieb
 4 Toma de fuerza posterior



STANDARD
 Mekfarmer 150-170-220
 Mekfarmer K180-K230-K270

OPTION
 Mekfarmer 100-120

RIGID TRACK ERADICATOR

Ancora rompitraccia
 1 Effaceur de trace
 2 Spurlockerer
 3 Eliminador de rostro



OPTION
 Mekfarmer 80-100-120-150-170-220
 Mekfarmer K180-K230-K270

REAR LEVELLING BAR

1 Barra livellatrice posteriore
 2 Barre niveleuse arrière
 3 Hintere Planierschiene
 4 Barra niveladora trasera













STANDARD
 Mekfarmer 100-120-150-170-220
 Mekfarmer K180-K230-K270

OPTION
 Mekfarmer 80

				540 RPM	1000 RPM	Cod.	
Mekfarmer 80	-	-	324	-	-	8201423	standard
	19	21	293	-	-	8201423	option
	21	19	358	-	-	8201427	
	18	22	265	-	-	8201427	
Mekfarmer 100 - 120	22	18	396	-	-	-	standard
	17	16	311	-	-	8201424	
	16	17	275	-	-	8201428	
	18	15	351	-	-	8201428	
	15	18	244	-	-	8201429	
Mekfarmer 150	12	21	-	309	-	8201430	option
	13	20	-	352	-	8201430	
	32	24	348	-	-	8066254	
	24	32	-	362	-	8066256	
	30	26	301	-	-	8066257	
	33	23	374	-	-	8066258	
Mekfarmer 170 / K 180	25	31	-	389	-	8066258	option
	22	34	-	312	-	8066259	
	26	35	-	359	-	8066239	
	35	26	350	-	-	8066232	
	21	40	-	253	-	8066233	
	23	38	-	292	-	8066233	
	38	23	430	-	-	8066234	
	24	37	-	313	-	8066234	
	37	24	402	-	-	8066235	
	25	36	-	335	-	8066235	
	36	25	375	-	-	8066236	
	27	34	207	383	-	8066236	
34	27	328	-	-	8066237		
28	33	221	410	-	8066237		
33	28	307	-	-	8066238		
29	32	236	438	-	8066238		
32	29	288	-	-	-		
Mekfarmer 220 / K 230	18	19	-	332	-	8201426	standard
	19	18	-	371	-	8201433	
	16	21	-	267	-	8201433	
	21	16	-	461	-	8201434	
	17	20	-	298	-	8201434	
Mekfarmer K 270	20	17	-	413	-	8066462	option
	30	39	-	365	-	8066462	
	23	46	-	238	-	8066460	
	27	43	-	298	-	8066461	
	33	36	-	435	-	8066463	

Technical data

DATI TECNICI / DONNÉES TECHNIQUES / TECHNISCHE DATEN / DATOS TECNICOS

																								
			KG	KG			KG	KG	KG	KG	KG	KG	KG	KG	KG	KG	KG	KG	KG	KG	KG			
Mod. Mekfarmer	HP	rpm	cm	cm	n.	cm	KG	KG	KG	KG	KG	KG	KG	KG	KG	KG	KG	KG	KG	KG	KG	KG		
							Ø 477 1	Ø 525 2	Ø 525 3	Ø 405 x MekFarmer 80 Ø 370	Ø 450	Ø 500	Ø 460	Ø 412	Ø 500	Ø 406	Ø 464	Ø 500	Ø 550					
80-110	30-44	540		110	113	10	8-27	340			308											342		
80-130	40-50	540		130	133	12	8-27	375			338											396		
80-150	50-60	540		150	153	14	8-27	410			368											450		
80-170	60-80	540		170	173	16	8-27	445			398											504		
80-190	70-80	540		190	193	18	8-27	480			428											558		
100-200	60-70	540	1000	200	205	20	8-27	680			670	700		690	680							780	810	
100-230	65-80	540	1000	230	235	22	8-27	730			700	730		720	710							830	860	
100-250	70-90	540	1000	250	255	24	8-27	780			750	780		770	760							880	910	
100-300	80-100	540	1000	295	300	28	8-27	880			850	880		870	860							980	1010	
120-250	90-110	540	1000	250	255	20	10-30		935	980		910		910	880	950						1110	1180	1250
120-300	100-120	540	1000	295	300	24	10-30		1092	1137		1100	1200	1100	1070	1140						1195	1265	1335
120-350	100-120	540	1000	345	350	28	10-30		1192	1237		1200	1300	1200	1170	1240						1295	1365	1435
150-250	90-120	540	1000	243	252	20	10-30		1092	1138		1102		1102	1072	1142						1242	1312	1382
150-300	110-140	540	1000	288	300	24	10-30		1212	1258		1223	1323	1220	1183	1253						1362	1432	1502
150-350	120-150	540	1000	345	350	28	10-30		1282	1328		1293	1393	1290	1253	1323						1432	1502	1572
170 - 300 K180	100-130	540	1000	295	300	24	10-30		1190	1236		1220	1320	1223	1180	1250						1420	1472	1552
170 - 350 K180	110-150	540	1000	345	350	28	10-30		1330	1376		1360	1460	1360	1320	1390						1570	1640	
170 - 400 K180	120-170	540	1000	395	400	32	10-30		1470	1516		1500	1600	1500	1460	1530						1710	1780	
220-300	140-160		1000	295	300	24	10-30		1255	1301		1285	1385	1285	1245	1315						1450	1500	1570
220-350	150-170		1000	345	350	28	10-30		1400	1446		1430	1530	1430	1390	1460						1640	1730	
220-400	170-200		1000	395	400	32	10-30		1550	1596		1580	1680	1580	1540	1610						1790	1860	
220-450	180-220		1000	445	450	36	10-30		1700			1730	1830	1730	1690	1760						1940	2010	
K 230-300	140-160		1000	295	300	24	10-32		1255	1301		1285	1385	1285	1245	1315						1450	1500	1570
K 230-350	150-170		1000	345	350	28	10-32		1400	1446		1430	1530	1430	1390	1460						1640	1730	
K 230-400	170-200		1000	395	400	32	10-32		1550	1596		1580	1680	1580	1540	1610						1790	1860	
K 230-450	180-230		1000	445	450	36	10-32		1700			1730	1830	1730	1690	1760						1940	2010	
K 270-300	150-180		1000	295	300	24	10-32		1550	1595		1590	1690	1590	1550	1620						1730	1790	18060
K 270-350	150-200		1000	345	350	28	10-32		1710	1750		1700	1760	1760	1720	1810						1900	2010	
K 270-400	160-230		1000	395	400	32	10-32		1935	1926		1900	2000	1900	1860	1930						2110	2180	
K 270-450	180-270		1000	445	450	36	10-32					2060	2160	2060	2020	2090						2270	2340	

- 1** Tubo centrale Ø 102 (Ø 477) **GB** Central tube Ø 102 (Ø 477) **F** Tuyau centrale Ø 102 (Ø 477) **D** Zentral Rohr Ø 102 (Ø 477) **E** Tubo central Ø 102 (Ø 477)
2 Tubo centrale Ø 164 (Ø 525) Central tube Ø 164 (Ø 525) Tuyau centrale Ø 164 (Ø 525) Zentral Rohr Ø 164 (Ø 525) Tubo central Ø 164 (Ø 525)
3 Tubo centrale Ø 273 (Ø 525) Central tube Ø 273 (Ø 525) Tuyau centrale Ø 273 (Ø 525) Zentral Rohr Ø 273 (Ø 525) Tubo central Ø 273 (Ø 525)

